

SERIES AL2000
 SLOT DIFFUSER

MARGIN B4
 SURFACE MOUNT WITH PLASTER FRAME

STANDARD INDUSTRY TOLERANCES APPLY. SPECIFICATIONS SUBJECT TO CHANGE WITHOUT NOTICE.

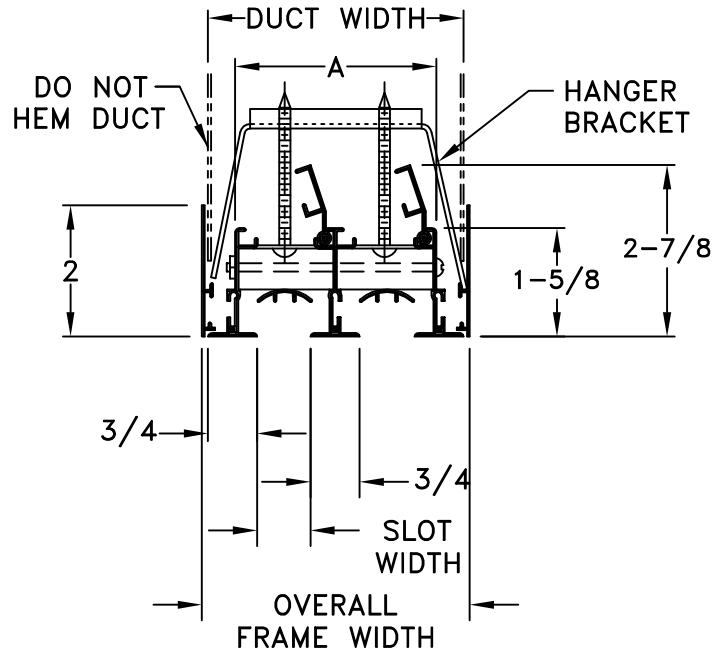
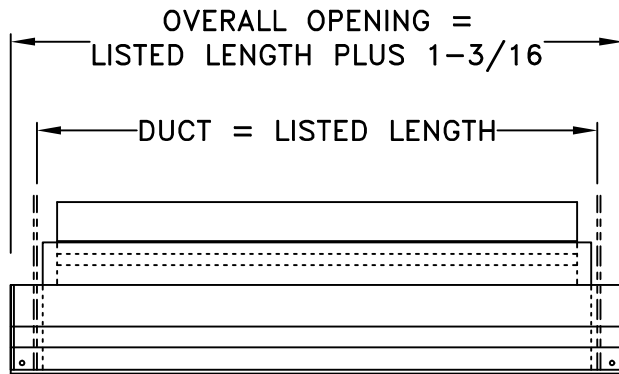

- FOR CONCEALED MOUNTING OF FLUSH FRAME ALONG WALLS/FIXTURES
- CONTRACTOR TO FRAME OPENING TO INSURE STRAIGHT LINE INSTALLATION (TYPICAL ALL INSTALLATIONS)



MARGIN ONLY



MARGIN AND PATTERN CONTROLLER

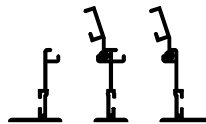

MARGIN AND DAMPER

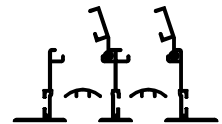

MARGIN, DAMPER AND PATTERN CONTROLLER

SLOT WIDTH	TYPE	A	DUCT WIDTH	OVERALL FRAME WIDTH
1/2	50	1-1/4 X NO. OF SLOTS	A + 13/16	A + 15/16
3/4	75	1-1/2 X NO. OF SLOTS	A + 13/16	A + 15/16
1	10	1-3/4 X NO. OF SLOTS	A + 13/16	A + 15/16

Series AL2000 is a Slot diffuser available in 12-72 inch lengths. Units are available in 1-10 slots with a choice of 1/2, 3/4 or 1" slot width, with or without adjustable deflector. Extruded aluminum construction with adjustable deflectors. White finish with black blades or satin anodized.

PROJECT: _____
 ARCHITECT: _____
 ENGINEER: _____
 CONTRACTOR: _____
 LOCATION: _____



J&J REGISTER
 AIR DISTRIBUTION PRODUCTS