

Permissible for use with the following Models: TLC/UT/ST/GT/JSC/SPR/JM/ALT/CF

READ INSTRUCTIONS CAREFULLY BEFORE STARTING THE PROJECT. REMEMBER THAT SAFETY COMES FIRST. OUR CHIMNEY SYSTEMS ARE DESIGNED FOR INSTALLATION BY A QUALIFIED PERSON IN ACCORDANCE WITH LOCAL BUILDING CODES.

Selkirk Chimney parts are Listed and produced under the Factory Inspection and Follow-up program of Underwriters Laboratories, Inc. and carry the LISTING MARK illustrated here.



CAUTION: WEAR CUT RESISTANT GLOVES WHILE HANDLING METAL PARTS TO AVOID PERSONAL INJURY. SHARP EDGES OR PROJECTIONS CAN CUT YOU.

Tested to: UL 103 HT, ULC-S604, ULC-S610, ULC-S629

Read the following instructions in their entirety before assembling and installing. Refer to the main Chimney System Installation Instructions for further information on installation of Selkirk chimney.

The URBK/JURGK-1 will provide lateral support to the chimney above the roof line. The URBK/JURGK-1 is required when the chimney extends 5 feet (1600mm) or more above the roof penetration. The kit contains Telescoping Legs, Support Band, Roof Angle Brackets and hardware package.

The Universal Roof Brace Kit (URBK/jJURGK-1) accommodates most models of chimneys with outer diameters ranging from 7" through 13".

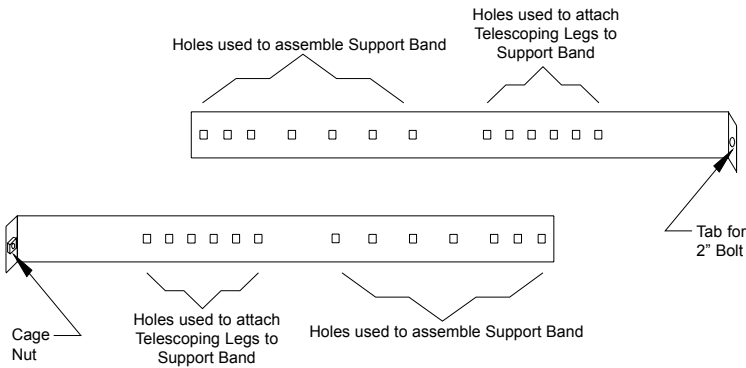

Support Band Holes Identifier
Figure 1

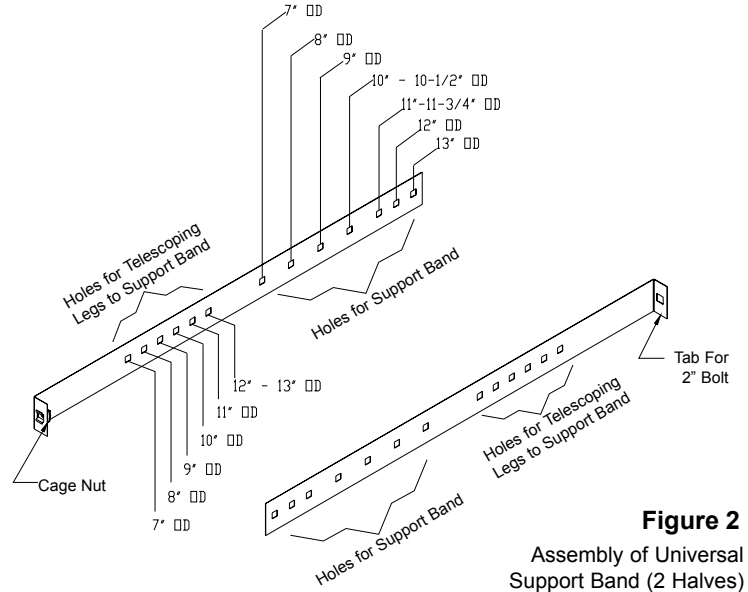

Figure 2
Assembly of Universal Support Band (2 Halves)

To Install:

A. Measure the **outside (OD)** diameter of your chimney.

Assembly of Support Band:

B. From the single row of holes (see Figures 1 and 2), select the hole in each half that corresponds to the outside diameter identified with the chimney being installed. Place the two halves together. Insert an elevator bolt through the chosen holes (Ex - for a 10" OD chimney, place the elevator bolt through the holes identified for 10" OD). The elevator bolt should be oriented as shown in Figure 3. Secure the center bolt with washers and 1/4" flanged nut (see Figure 3). **NOTE:** On smaller diameter chimneys the excess band material can be cut off.

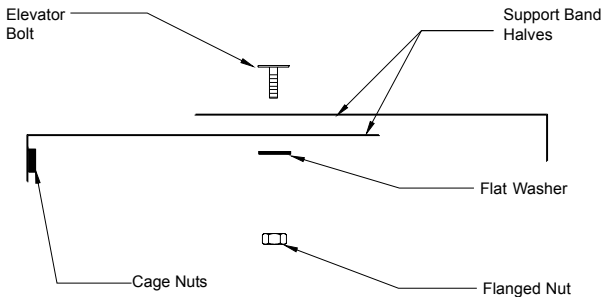

Topview assembly of Support Band - Elevator Bolt, Washers and Nut
Figure 3

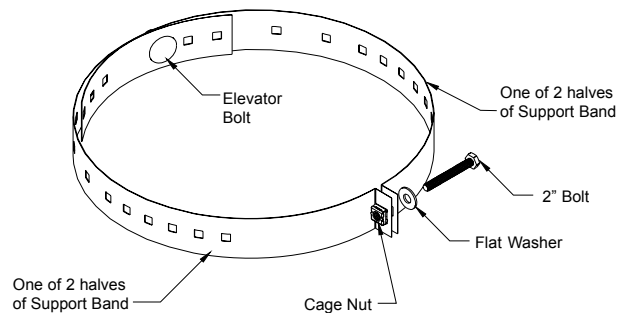

Universal Support Band formed into a circle
Figure 4

C. Form the band into a circle (see Figure 4) and loosely connect tabs using the supplied 2" bolt into the cage nut located on one of the two formed tabs.

D. Select the hole in each half that corresponds to the OD of the chimney. Insert an elevator bolt in each of the holes (1 per side).

E. Position the Support Band approximately two thirds of the way up the chimney height (see Figure 8). The preferred location is next to a joint, immediately above or below a Locking Band. Secure Support Band by tightening the 2" bolt. **NOTE:** Only one chimney joint should be above a Roof Brace Kit. An additional Roof Brace Kit may be required for taller systems.

Preparation of Telescoping Legs:

- F. Assemble the telescoping legs by sliding the supplied hose clamp over larger diameter leg and then inserting smaller diameter leg into larger diameter leg. Temporarily hold legs together by tightening the hose clamp over the cut section of larger diameter leg (see Figure 5). Repeat for the other telescoping leg assembly.
- G. Place a flat washer on the elevator bolts and attach the angled end of each of the telescoping legs to the 2 elevator bolts on the Support Band with washer and nut (see Figure 6).
- H. Attach the other end of each telescoping leg assembly to an Angle Bracket using one (1) 1/4-20 X 1" bolt and nut (see Figure 7).

Assembly of Telescoping Legs with Hose Clamp

Figure 5

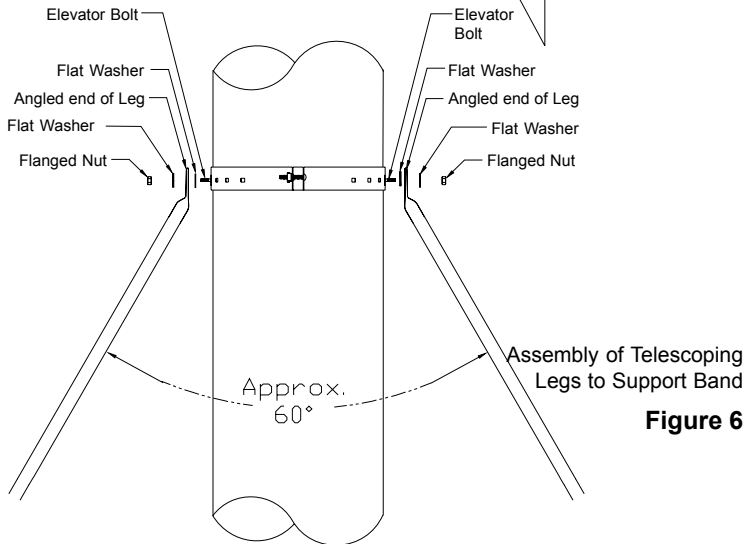
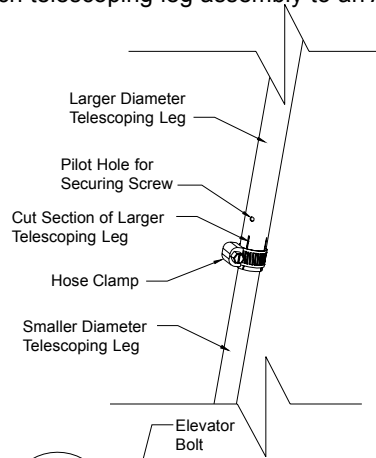
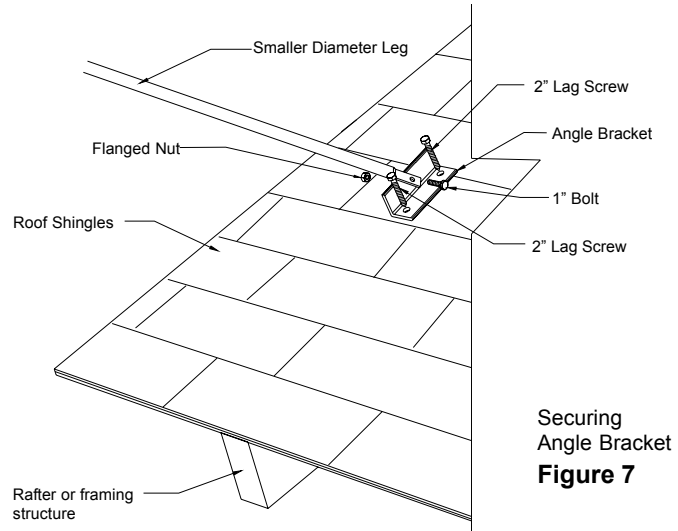
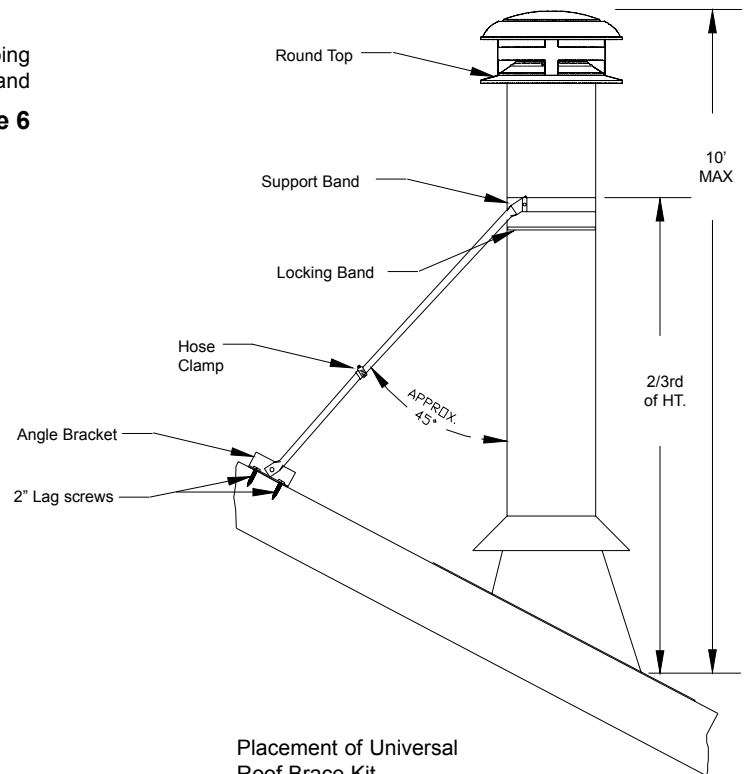

Figure 6

- I. Determine the location of the two Angle Brackets on the roof structure. Ensure the fasteners are into rafters or framing and not just roof sheathing. Secure the Angle Brackets to the roof structure using two (2) 1/4 X 2" lag screws per brackets (see Figure 7). Apply a thin layer of caulking under the angle bracket (before securing in place) as well as over the lag screw heads.
- J. Make sure the chimney is level and plumb. Check all required dimensions and angles, adjust if necessary. For added security, lock legs in place by using 1/8" x 1/2" stainless steel self tapping screw (supplied) through the pilot holes found near the hose clamps (Figure 4).
- K. The two telescoping legs should form an angle of about 60° to give support to the chimney in all directions. The angle of the telescoping legs should be approximately 45° from vertical when fastened to the roof (see Figures 6 & 8).



Securing Angle Bracket
Figure 7



Placement of Universal Roof Brace Kit

Figure 8

NOTE: Do periodic inspections of all fasteners including the hose clamps as high winds can cause the chimney system above the roof to vibrate and in time loosen some of the fasteners.



Hart & Cooley, Inc. 616.656.8200 p
5030 Corporate Exchange Blvd. SE 616.656.6399 f
Grand Rapids, MI 49512
info@hartcool.com
www.hartandcooley.com